

Double-Ended Cordsets
BCC M414-E834-8G-668-PS54N2-050
 Order Code: BCC0JF2

BALLUFF

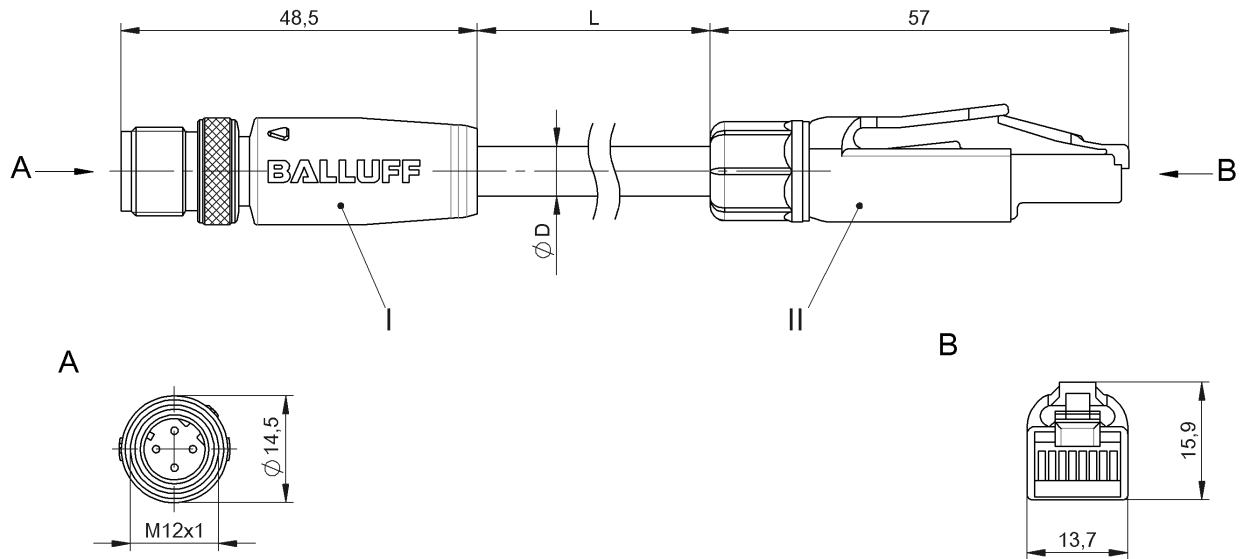

Basic features

Application	Profinet , CAT 5
Approval/Conformity	CE cULus WEEE

Electrical connection

Bending radius min., fixed cable	5 x D
Bending radius min., flexible cable	15 x D
Cable	PUR Shielded Green, 5 m, drag chain compatible
Cable diameter D	6.70 mm ±0.30 mm
Cable, bending cycles min.	2 mil.
Cable, note	Profinet Type C, CAT 5E by IEC 61156-6
Conductor cross-section	22 AWG
Connection 1	M12x1-Male, straight, 4-pin, D-coded
Connection 2	RJ45-Male, straight, 4-pin
Number of conductors	4
System	Molded/assembled

Electrical data

Operating voltage Ub	125 VDC / 125 VAC
Rated current (40 °C)	1.0 A
Transfer rate	10/100 Mbit/s

Environmental conditions

Cable temperature, fixed routing	-40...80 °C
Cable temperature, flexible routing	-20...60 °C
IP rating	IP67/IP20

Material

Cable jacket material, note	Shielded
Cable jacket, material	PUR
Cable shield	Aluminum foil and copper braid
Material contact carrier	PUR
Material contacts	Brass
Material cover nut	Brass nickel-plated
Material grip	PUR/PA

Mechanical data

Acceleration max., drag chain	2 m/s ²
Cable jacket, color	Green
Cable length L	5.00 m
Cable properties	drag chain compatible
Horizontal travel permitted, drag chain	5 m
Tightening torque pigtail	0.6 Nm/-
Traverse speed max., drag chain	200 m/min
Vertical travel permitted, drag chain	5 m

Remarks

Cable construction acc. to UL-AWM Style 20549
 Halogen-free per DIN VDE 0472 Part 815
 Silicone-free
 Flame resistance acc. to FT1
 Enclosure rating per IEC 60529 or ISO 20653, only in screwed state with the associated mating piece.

Connector Drawings

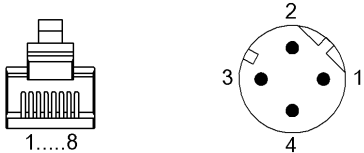

- | | |
|---|--|
| <p>II</p> <p>PIN 1: yellow</p> <p>PIN 2: orange</p> <p>PIN 3: white</p> <p>PIN 4: not used</p> <p>PIN 5: not used</p> <p>PIN 6: blue</p> <p>PIN 7: not used</p> <p>PIN 8: not used</p> | <p>I</p> <p>PIN 1: yellow</p> <p>PIN 2: white</p> <p>PIN 3: orange</p> <p>PIN 4: blue</p> |
|---|--|

Wiring Diagrams

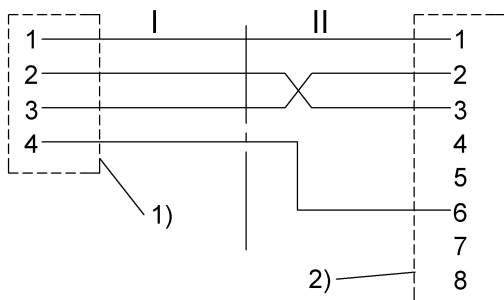

- 1) Shield on cover nut
 2) Shield on housing